

Manuale utente - User's manual - Benutzerhandbuch - Guide de l'Utilisateur - Manual de usuario

DISPLAY TOUCH SCREEN



RPS SpA

via Somalia, 20

20032 Cormano (MI)

Tel. +39 02 66327.1

Fax +39 02 66327.231

www.aros-solar.com

CONTENTS

PRESENTATION	3
CONFIGURATION	4
Overview	4
Basic interactions.....	7
Description of the Menu	8
Measurements	8
Historical data	11
Configuration.....	15
Alarms and statuses	28
Actions	29
Information	30
TECHNICAL DETAILS.....	32
Technical specifications.....	32
Compatibility Protocols	32
software version	32

PRESENTATION

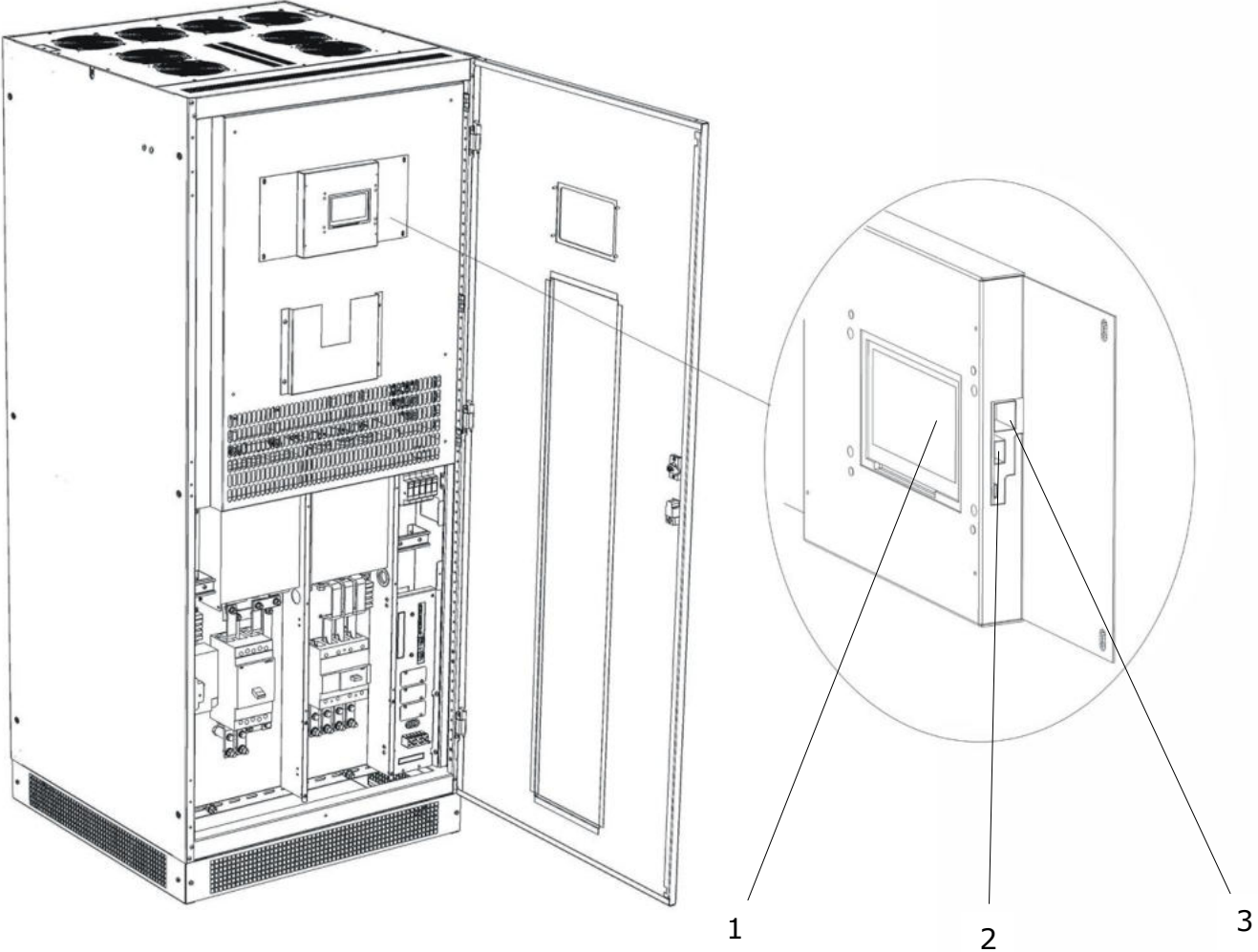

- 1. Touch screen
- 2. USB port
- 3. Ethernet port

Overview

Sirio Central inverters have a new man-machine interface (MMI) as standard, consisting of a colour *LCD Touch* panel. The characteristics and the quantity of information enrich the experience of user interaction with the solar inverter.

Everything can be done with just a touch.

When the inverter is started up for the first time after commissioning, a screen appears asking you choose the country where the inverter is installed:



Press the arrows on the right to scroll between the countries currently managed. Once the choice has been made, simply touch the image of the Earth to proceed with the configuration:

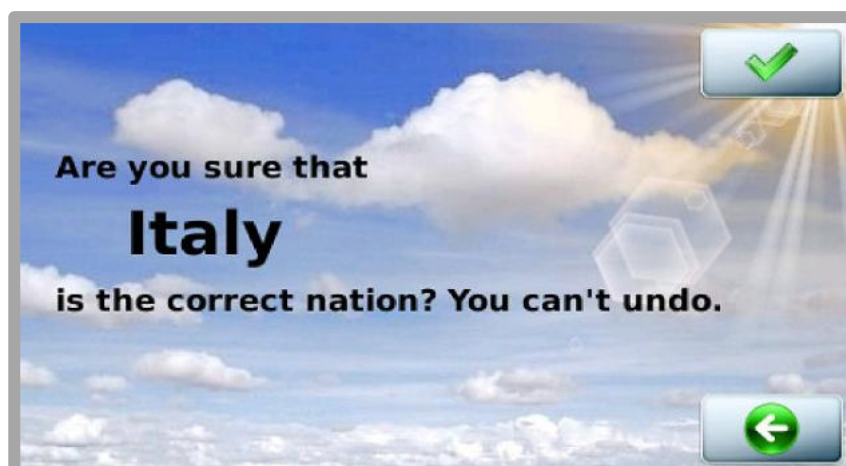

You can confirm or cancel your choice going back to the previous screen.



CAUTION: Choosing the country configures the inverter to the values prescribed by the regulations in force in the country of installation. Once you have made your choice, you cannot change this setting without contacting Technical Assistance Service staff. The interface language can still be changed at a later date using the [ADVANCED SETTINGS](#) menu.

The next times the device is turned on, after the welcome AROS logo, the screen will appear as shown below (the background color may vary according to the inverter operating conditions):

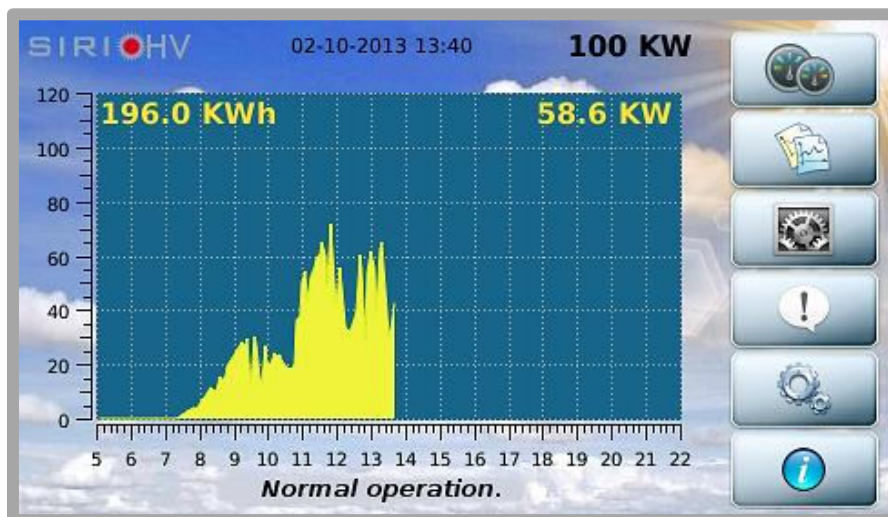

The screen consists of the following main areas:







1. At the top of the screen, the model, date, time and rated power of the inverter are displayed from left to right.
2. The daily graph showing the power delivered is shown in the middle of the screen. The horizontal scale represents the hours (from 5 to 22 i.e. 5 am to 10 pm) while the vertical scale represents the kW. In the top right of the graph is the value of the instantaneous power while on the left is the energy produced during the current day.
3. At the bottom of the screen is a line providing status information, with messages that alternate once per second.
4. On the right of the screen, there is a column with buttons that allow you to navigate within the interface.

After 5 minutes of inactivity, the LCD screen enters screensaver mode. Just tap it to return to normal viewing. The following symbols may appear on the off screen during daytime:



The first symbol indicates that inverter operation is regular, the second that solar radiation is low and the third indicates an alarm.

The buttons on the right-hand side of the column let the user access the main functions; they have the following symbols and meanings:

	Inverter measurements	Page 8
	Data log	Page 11
	System configuration	Page 15
	Inverter statuses and alarms	Page 30
	Inverter actions	Page 29
	Information	Page 30

Note that, on the main screen, touching the graph area of the screen displays the energy produced monthly:

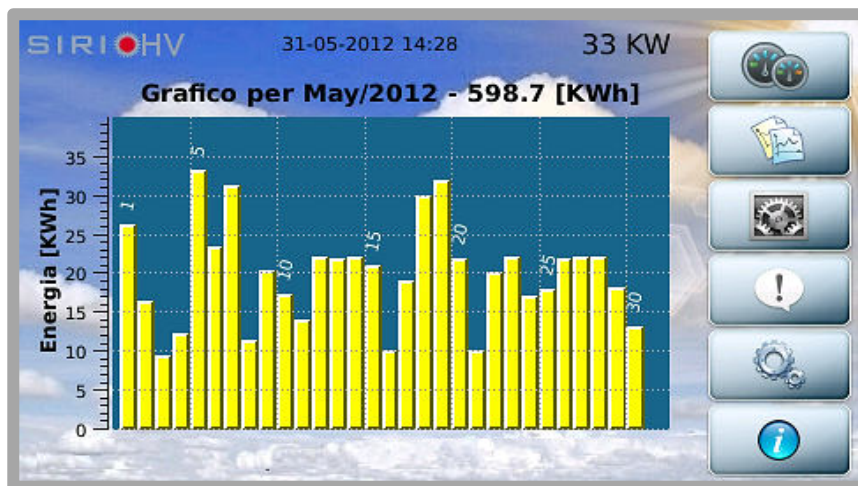

Swiping the finger on the screen from left to right or from right to left it's possible to see data of previous/next month. Touching it again will display the annual graph:



Swiping the finger on the screen from left to right or from right to left it's possible to see data of previous/next year

Touching it again returns you to the home page.

Basic interactions

All the features and customizations of the system can be queried using the following actions:

- **Touch:** touching the button or specific area of the screen;
- **Swipe:** moving your finger on the screen while holding it down, from right to left or from left to right. This may be required to navigate through the daily graphs or between different screens on some occasions.

Whenever a touch or swipe is recognized, the MMI will confirm with a beep.



For file transfer, a USB flash drive with a single FAT32 partition is required; otherwise it will be impossible to complete the data saving operation correctly.

Description of the Menu

MEASUREMENTS

From the main window, as seen, you can access the other areas of the interface. In particular, press the  button to consult the inverter measurements:

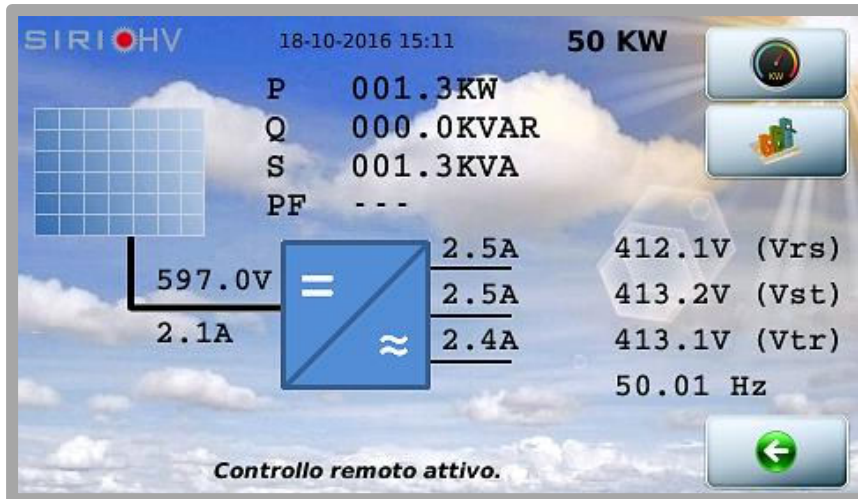

The synoptic panel shows all the main device measurements.

The two buttons on the right-hand side allow you to view the temperatures measured inside the inverter and the measurements of the four analogue probes if connected.

By pressing the Temperature button  accesses the following screen.

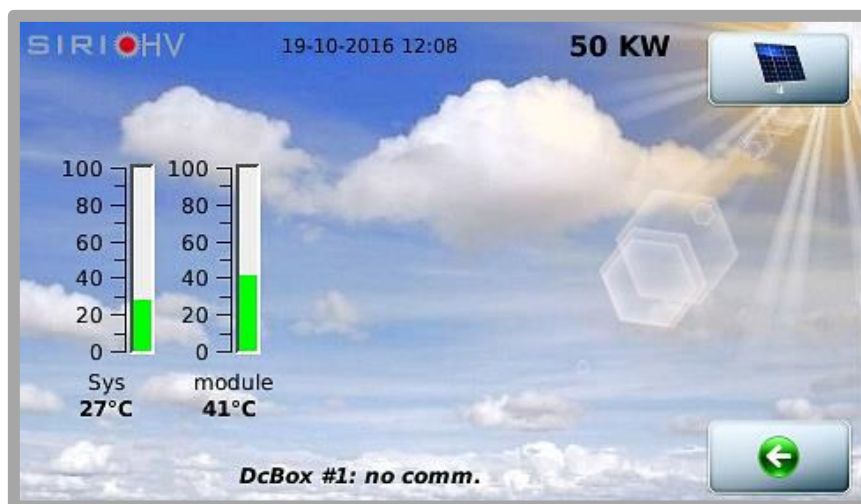

If a DC-BOX is present that monitors the current for each individual input

(and suitably configured), pressing the  button allows for viewing the current readings for each input.

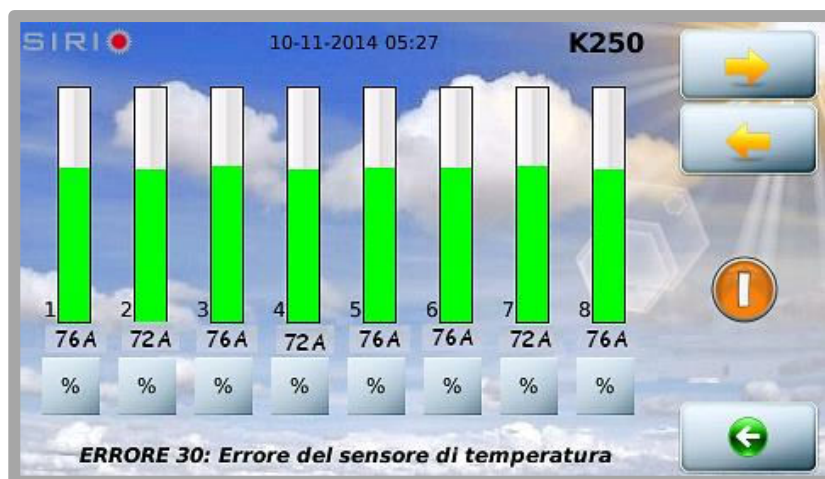

In this window it is possible to change the 'weight' parameter for each input in relation to the photovoltaic panels supplied, by pressing the relative '%' key located beneath each reading. For example: if inputs 1, 2, 3, 5, 6, 7 and 8 have a rated current of 180 A while input 4 has a rated current of 140 A, the relevant settings are:

$$\%1 = 100\% - \%2 = 100\% - \%3 = 100\% - \%5 = 100\% - \%6 = 100\% - \%7 = 100\% - \%8 = 100\%;$$

$$\%4 = 140/180 \cdot 100 = 77.7 \rightarrow \underline{78\%}$$

See the next screen.

Press the '%' key to access the following screen where the weight of the single string (in this example, 78) can be set through the + / - buttons.

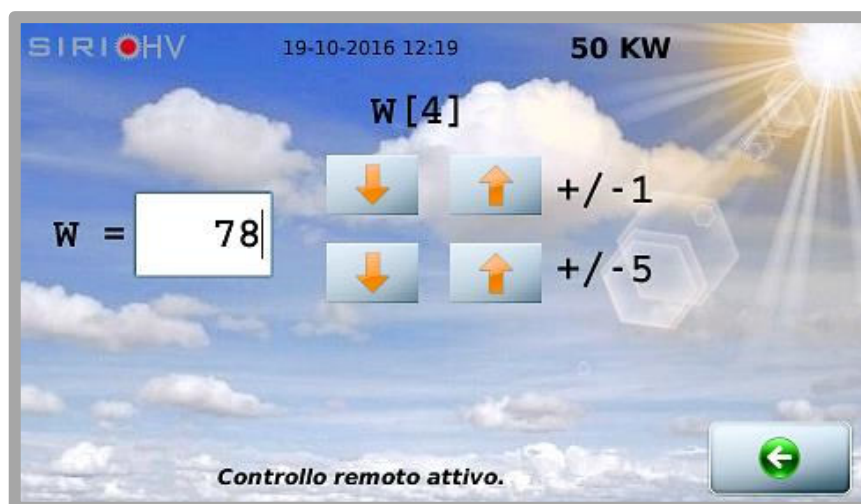

NOTE:

in the event that not all of the 8 inputs are used, the free input reading must be deactivated. Press the '%' key corresponding to the free input and set the 'weight' to zero.

By pressing the analogue probes  accesses the following screen.



The button  is used to return to previous windows, this button is available in all windows.

HISTORICAL DATA

The  button allows you to access the screens for managing the historical inverter data:



To **view the logs**, press the button with the  symbol. Then select the measurements to be displayed (only two measures can be displayed at the same time):



To select a measurement, press the corresponding button. A white tick will appear on a green background to highlight the choice. If you want to deselect an item, simply press the button again.

To proceed with reading of graphs, press button 

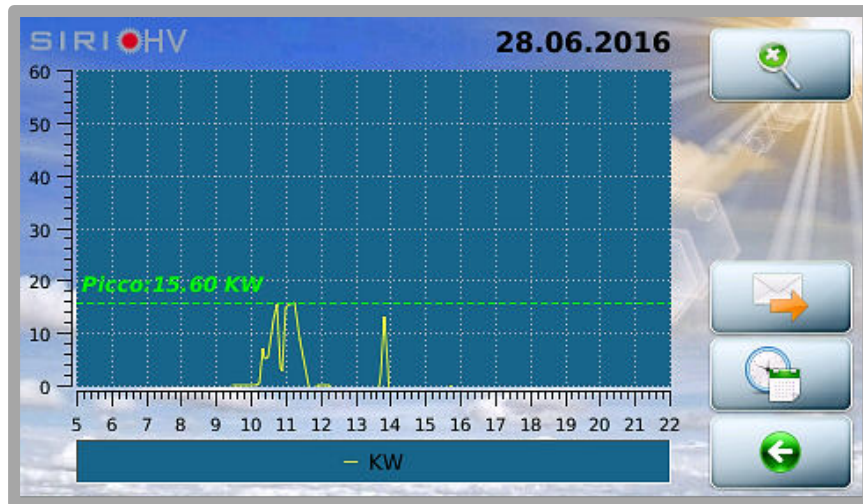

Now you can :

- Go ahead and back one day with a simple touch: scrolling across the screen from right to left and from left to right respectively
- With the lens button to enlarge the graph.
- Send graphic via email (the button appears only if the service is configured).
- Select the day you wish to view from the calendar

The units of measurement appear at the bottom. The horizontal axis is always temporal in the time range [5 - 22]. The vertical axis on the left has the left-hand unit of measurement and the one on the right has the right-hand unit of measurement. The curves always have different colours.

To save the historical data on a USB flash drive, press the button with the



symbol. The following window appears:



As already mentioned, the USB flash drive must be FAT32 (VFAT) formatted and have a single partition. Many USB flash drives that have dedicated protection software with special partitioning schemes may not work.

After inserting the USB flash drive, wait a few seconds and press the button with the  symbol to allow the system to recognize the memory (recognition is not automatic). If the operation succeeds, the following message will appear:



Otherwise:



Press  again to copy.

When finished, press the button with the  symbol in order to safely remove the USB flash drive.

Note that over time, the historical data takes up the device memory.

The  button allows you to manage the archives, eliminating annual data no longer of interest:



To select the year, drag your finger from right to left or from left to right.

When  is pressed, the year will be highlighted in red. Touch the screen to confirm deletion.

Please note that data deletion cannot be reversed.

In order to **download the system log** from the control board (file history and ram, useful if required by Technical Assistance in order to diagnose any problems), press the button with the  symbol.

From the screen that follows



follow the instructions to start downloading the system card logs. To cancel the operation, go back to the previous screen.

Or press  to cancel the operation and return to the previous screen.

At the end of the download, you can send the logs by e-mail or copy to a USB flash drive.



The button  allows the user to download the logs of the system board and of the display on USB key. Use the same procedure seen before.

CONFIGURATION

From the main screen, press  to access parameter configuration:



On the right are the buttons that allow for setting the various parameters, namely:

- user settings
- advanced settings
- access to the terminal mode for low-level interactions with the inverter
- Service section, protected by password
- e-mail configuration section: this screen allows for setting the periodicity of the e-mails on an alarm or event basis

USER SETTINGS

These are activated by pressing  :

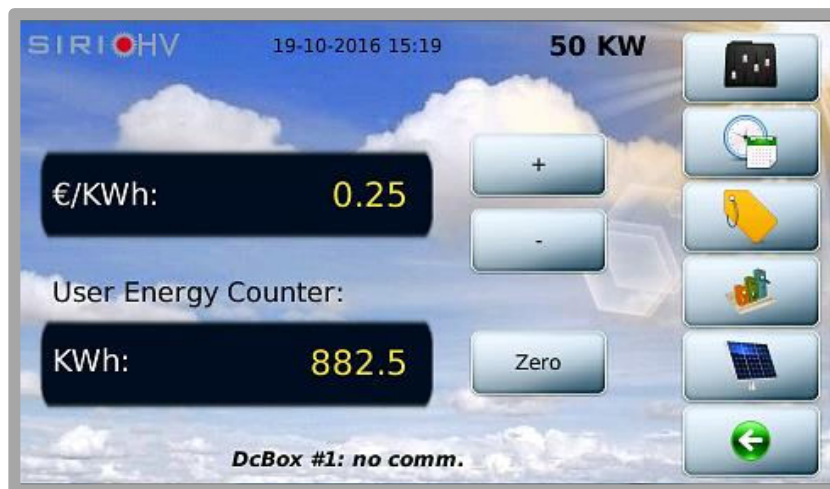

On this screen, you can manually set the €/kWh ratio and reset the partial hour meter for the energy produced.



Press  on the other hand to access screen brightness configuration and enable/disable the buzzer. If enabled, the buzzer will sound an alarm that disappears when the alarm stops. The alarm sound changes if an operator interacts with the interface. After 20 minutes of inactivity, if an alarm is still active, the sound will go back to the initial one.



The  button allows to set Date and Time on the inverter :



Press on the Month and Year to modify them.



WARNING: Modifying the Date and Time values during normal operation may alter the graphic depiction of the memorised data.



Press  to set the inverter identifier, needed in order to use the protocols on the 485 serial line and to identify the machine when transferring historical inverter data onto a USB flash drive. If the system has multiple inverters, it is compulsory for the identifiers to be all different from each other.



In the same window, we see that for each serial port, it is possible to specify whether the addressing is dynamic or static¹; this is a technical issue that regards the compatibility of communication protocols. In particular, this configuration data concerns the PVSER protocol (Proprietary Protocol).

Also from here, by pressing  you can specify the name of the system in which the inverter is installed or the section of the system:



¹ For more information, consult the SunVision 2 software user manual



Going back to user settings, using the  button, you can configure the four analogue probes (optional - e.g. radiation, temperature, anemometer etc, with electrical output 0-10 V):



By pressing one of four buttons, you configure the individual probe:



The single measurement, as seen, can be configured in detail:

- Description
- Unit of measurement
- Minimum value (corresponding to 0 VDC input)
- Maximum value (corresponding to 10 VDC input)

The probe can be enabled or disabled as desired.



Press the button with the  symbol to save the probe configuration. Consult the technical documentation for the 0-10 V probes to enter the correct configuration data.

From User Settings window by pressing the  button you can enter a percentage value which is the ratio between the photovoltaic field peak and the inverter rated power, this parameter is necessary when monitoring software is used, for comparing the various inverters of a single system.

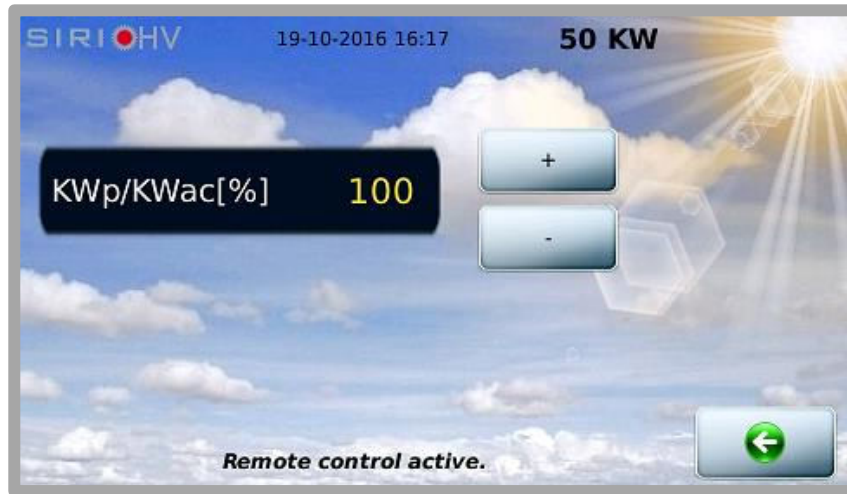

ADVANCED SETTINGS

From the Configuration Screen, pressing the  button allows for setting the following features:

- network settings
- activating or deactivating external commands through MODBUS
- configuring the external reading for the self-consumption function (by means of an external multimeter via MODBUS)
- Enable or disable the external commands MODBUS





Press  on the other hand, to go to the network parameters configuration window:



The IP address may be assigned statically, as in the previous figure, or can be obtained through a DHCP server. Touch the selection box to choose this setting:



Press the button with the  symbol once you have chosen the desired network configuration. When the IP addresses are entered, the software automatically performs a check, displaying the  and  symbols next to each edited address, showing whether the addresses have been entered correctly or not. Let's look at the other options.

UDP + FTP:

in the first line the user can set the value of the UDP port used for communications via UDP on the Ethernet network (e.g. SunVision2 monitoring software).

The value 33000 is pre-defined; it is possible to modify it and enter the desired value.

The subsequent lines can be used for setting the port range for using the NAT-FTP from remote.

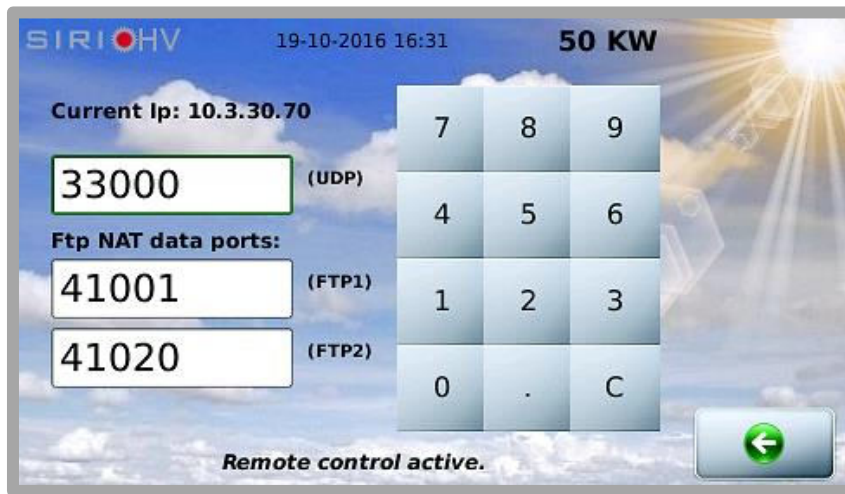

SMTP:

allows for configuring the outgoing electronic mail server.

The following features can be configured:

- 1 SMTP server address and relative port (first page).
- 2 Message header fields (From: To: Cc;; second page).
- 3 The username and password for authentication on the SMTP server (optional).





At the end of the configuration procedure, it is possible to send a test e-mail message to verify whether the settings are correct, by pressing the  button.

Lastly, press the  button to confirm the electronic mail configuration.

DNS :

on this page, enter any DNS server addresses that may be needed for the resolution of the names of the outgoing e-mail server:



VNC:

with dedicated software (both freeware and paid software are available on the internet, “Tight VNC” for example), it is possible to connect to the remote display from a personal computer :



You can configure the password (which must be confirmed) and the port used by the service. The default password is “secret”:

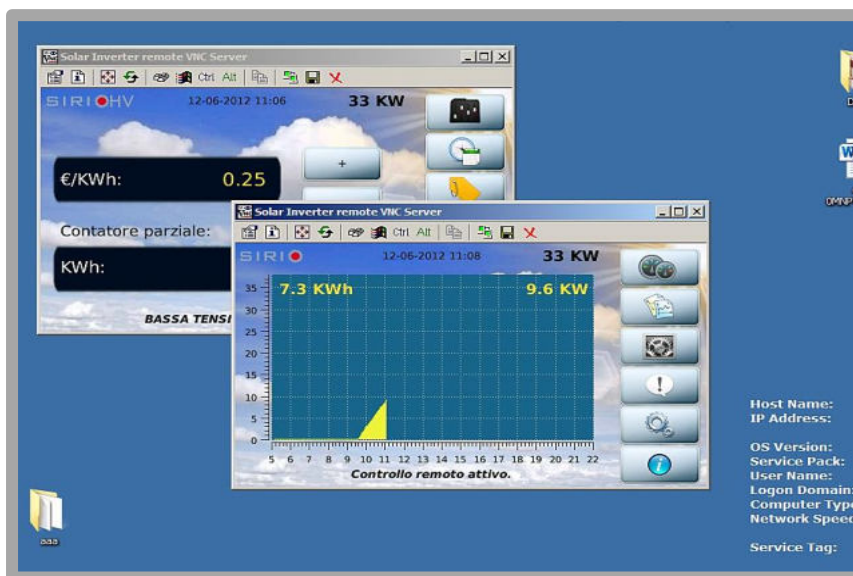

From Advanced Settings window by pressing



button allows for accessing the window for setting the display language.





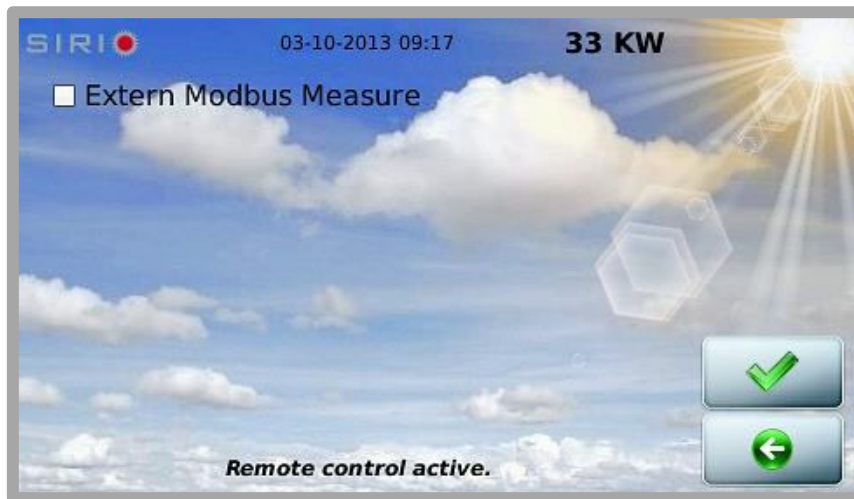

From Advanced Settings window by pressing  button makes the user access the configuration page of the external measures that can be used for the auto-consumption function.

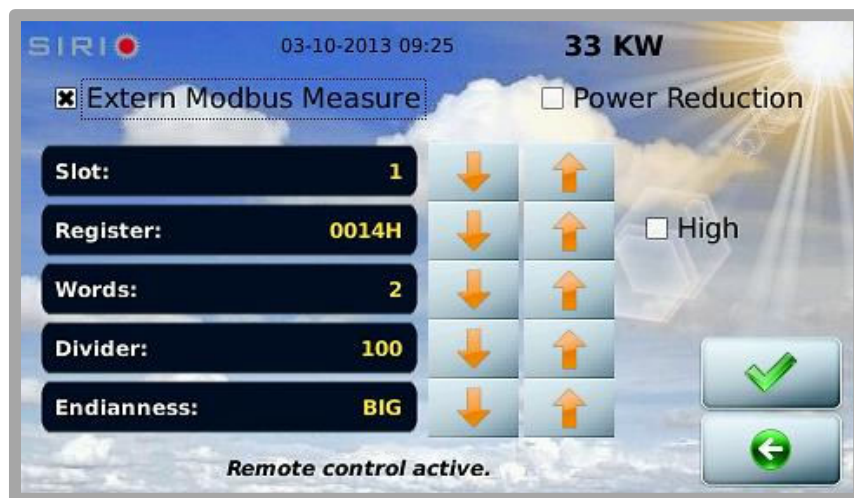

If the function Extern Modbus Measure is selected, a set of default parameters are presented. These parameters are prepared for the external instrument given by Aros Solar. Anyway it's possible to connect other brand instruments on the 485 bus; in this case an accurate reading of the manual is suggested to have the correct settings :



Use the  and  buttons to change the set of parameters. Select the High checkbox to change the upper part of the register. If the set of parameters are correct, the measure will appear in the upper right side of the screen. Now the button  can be used to accept the parameters.

If the Power Reduction checkbox is selected and hitting the  button again, the inverter will be configured as a master of a set or group of other inverters.

In this case we can scan the LAN to find the other inverters :

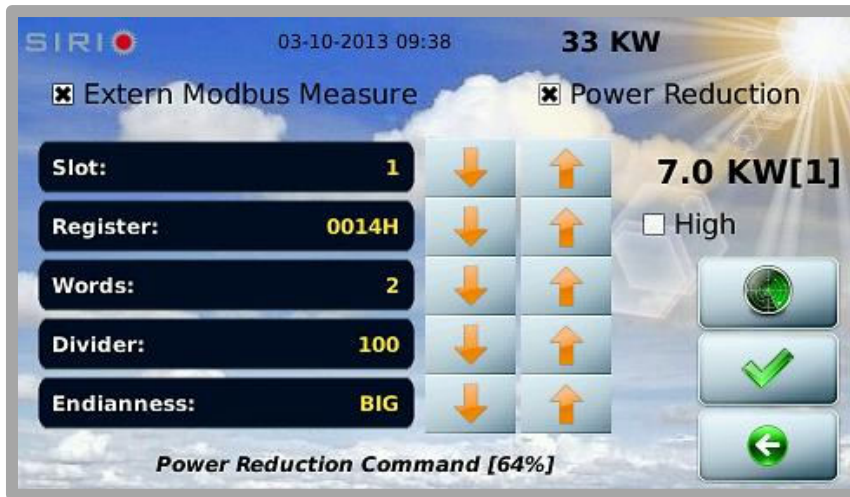

In order to scan the LAN, press the  button; this will lead the user to the screen:

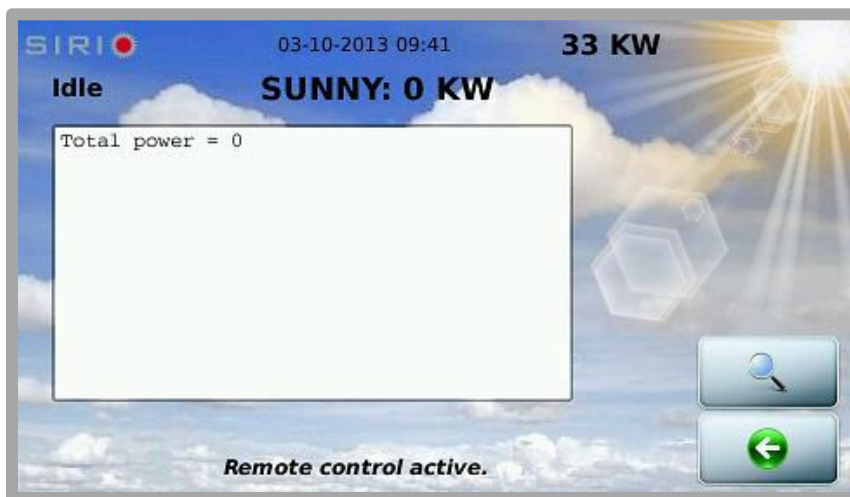

Press the button  to execute a scan of the LAN.

All the inverters must have the same label plant name to be found. See the self-consumption documentation for details.



TERMINAL MODE

From the Configuration Screen, pressing the  button allows for accessing the Terminal Mode in which the user can set the inverter with the various operating modes and parameters required by the regulations in force in the country of installation. For configuring the device correctly, refer to the relevant documentation IT2029, available on the website <http://www.aros-solar.com>

SERVICE

The Configuration Screen contains the  button reserved for personnel of the AROS Solar Technology Technical Assistance Service. Pressing this button allows for accessing various functions of the service protected by password.



From the same screen it is possible to recalibrate the touch-screen; to perform this operation, press the  button then press the tick symbol  to confirm : a guided procedure will start that allows for recalibrating the screen; follow the instructions appearing on the display.



E-MAIL CONFIGURATION





From the Configuration Screen, pressing the  button allows for accessing the settings screen for automatic e-mail transmission.

If the procedure described in the ADVANCED SETTINGS section, under the [SMTP](#) paragraph, is not completed correctly, it will not be possible to configure the e-mail transmission.



If the e-mail configuration procedure was carried out correctly, the following screen will appear:



Press  or  to enable or disable sending of a type of e-mail and press   to increase or decrease the delay time, in minutes, before sending an individual e-mail.

For example, if you want an e-mail to be sent 5 minutes after switching the device on, the configuration should be as follows:



We recommend that you enter a waiting time of at least 10 minutes to prevent e-mail from being sent during typical morning and evening switch-on attempts.

ALARMS AND STATUSES

Press  to enter the screen showing the inverter alarms and statuses :

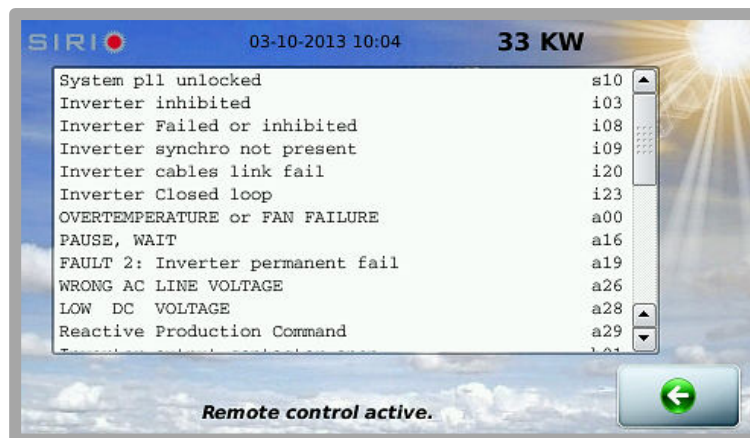

You can use your finger to scroll through the list of any alarms. Remember that in the event of an alarm, a sound will be emitted at 5-second intervals until the alarm disappears or the user touches the screen. If the user touches the screen, the sound will change intensity and timbre. If after 20 minutes the user has not deleted the alarm, the sound will go back to the original one.

The alarm sound can be enabled or disabled in the CONFIGURATION section in the [User settings](#) paragraph.

ACTIONS

Press  to enter the section where you can perform actions on the inverter :



The first button allows you to disable the inverter and re-enable it.

The second button allows you to restart the graphical interface for any display software updates, this action does not affect inverter operation in any way.

The button , if pressed, disables the UDP slave function in the self-consumption case.

To enable the function again, hit the same button, that in the meanwhile has changed its appearance,



To completely exclude a SLAVE inverter from the group, it is necessary to access the external reading configuration screen, from the Main Screen press the following buttons in sequence :



INFORMATION

Press  to enter the Information section.



This contains all the information regarding the inverter:

- The total energy produced by the inverter
- The total hours of operation
- The operating mode
- The identifier
- The maximum temperatures reached by the system (internal machine temperature) and the inverter (probes on power module heat sinks)
- Presence of the built-in isolation transformer
- The installation date (Year-Month-Day)
- The Euros saved
- The energy hour meter used (can be reset by the user)
- The maximum power reached

In addition to the above information, you can also display the current software version, the control panel firmware versions, the IP address of the network interface, the amount of free memory and the occupation of the flash drive:



By touching the screen, you can access more information about the status of communications:

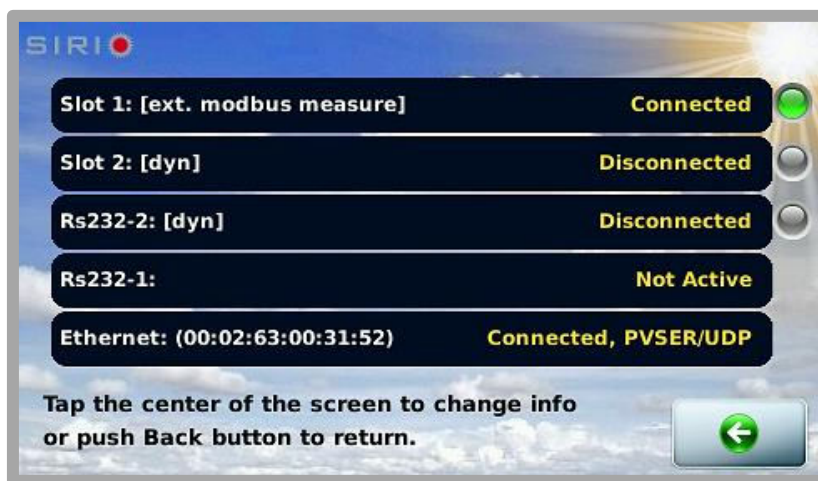

In this example, we see a PVSER/UDP connection on the Ethernet port and an external measure on slot 1.

The green/red blinking led means that on that slot is present receiving data. The grey led means no incoming data on the specific slot.

TECHNICAL SPECIFICATIONS

- LCD resistive touch screen, TFT, 480x272
- One Ethernet port
- One slot for a USB memory, FAT32

COMPATIBILITY PROTOCOLS

- PVSER²; static and dynamic addressing
- PVSER/UDP² (default port: 33000, configurable)
- MODBUS
- MODBUS/TCP
- RFB protocol (used by screen sharing programs, such as VNC), protected by (configurable) password. The default password is **secret**.
- Sunvision 2 (from 2.0.5 version upwards) could ask for a user/password to recover historical data. In this case the user is **ftpuser** and the password is **arosftp**.

SOFTWARE VERSION

- This manual refers to the 1.5.0 version of the touch screen software.

² Proprietary protocol



www.aros-solar.com

RPS SpA – *Riello Power Solutions*
Via Somalia, 20
20032 Cormano (MI)
Italy

0MNPHV12K55ENUA-02